

# WideTEK® 36CL-MF1

Scanner, 21" Touch, PC and integrated Stand for Canon Printer TX 3000/4000, iPF PRO 4000

Best MFP Solution in the Industry

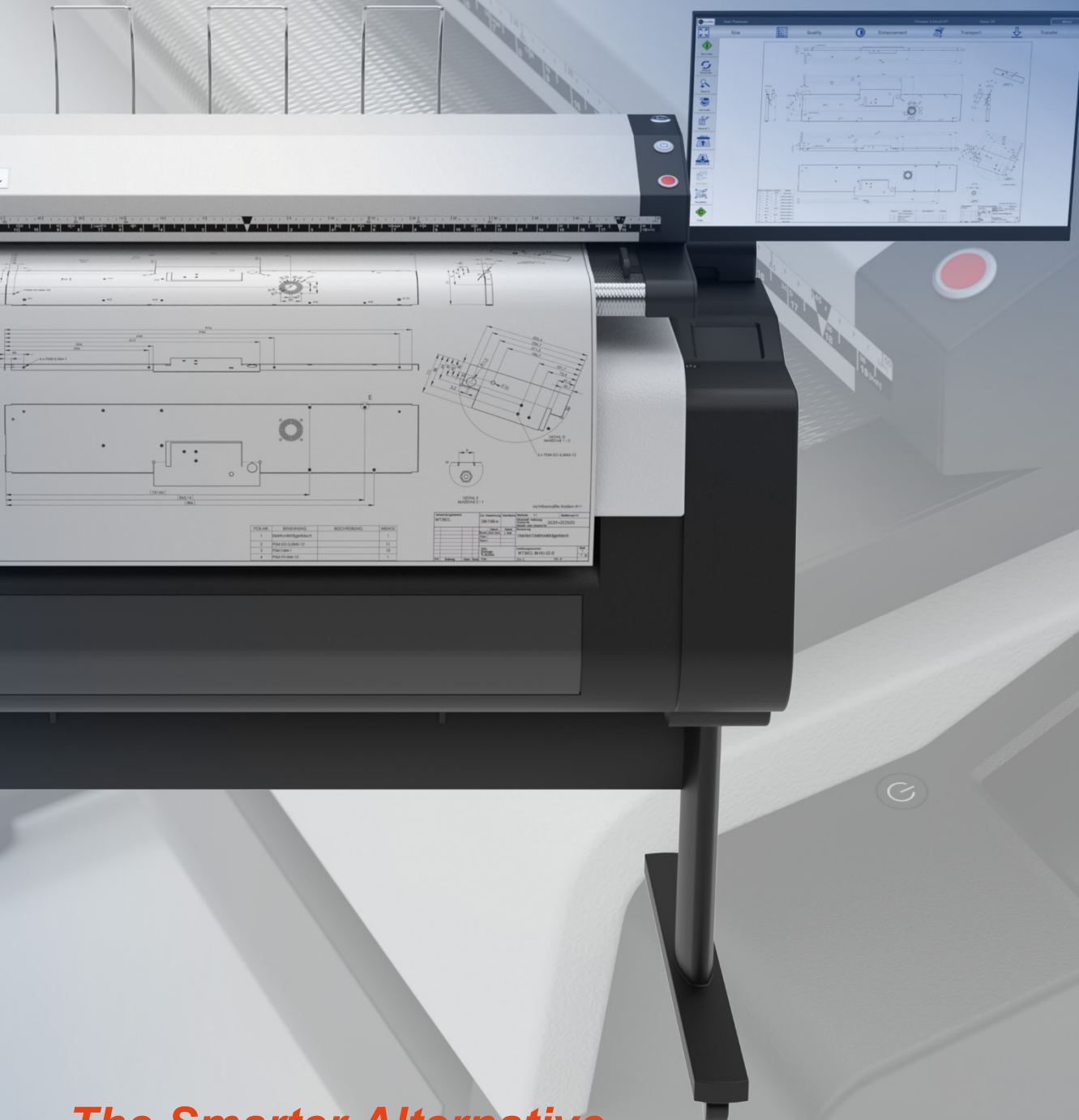

**The Smarter Alternative.  
Fully Featured Scanner, Copier and PC  
All in One Device.  
Available at a Highly Competitive Price.**



© 05\_2019 / EN



- SCANS AND COPIES UP TO 36 INCHES, FEEDS UP TO 38 INCHES
- 1200 x 1200 DPI SCANNER RESOLUTION
- FAST SCANS: 10 INCHES PER SECOND AT 200 DPI IN FULL COLOR
- ENDLESS SCANNING - SCAN UNLIMITED LENGTHS TO MULTIPAGE PDF
- 21" TOUCHSCREEN FOR SIMPLIFIED OPERATION
- SCANWIZARD AND PRINTWIZARD CANON LFP SOFTWARE
- VIRTUAL RESCAN, MODIFY IMAGES WITHOUT RESCANNING
- FACE UP SCANNING, REAR OR FRONT EXIT
- CENTER FEED OR RIGHT SIDE FEED WITH GUIDE
- DURABLE, ANTISTATIC, ALL METAL PAPER PATH
- AUTOMATIC SIZE AND POSITION DETECTION
- AUTOMATIC CROP AND DESKEW
- SUPPORTS SRGB, ADOBE RGB, NATIVE COLOR SPACES
- BUILT-IN CLOSED LOOP COLOR CALIBRATION
- INTEGRATED 64BIT LINUX, INTEL QUAD CORE, 8 GB RAM, 128GB SSD
- GIGABIT TCP/IP NETWORK INTERFACE
- BUILT TO LAST
- EASY ONE HOUR SETUP, PREINSTALLED SOFTWARE



*The WideTEK36CL-600-MF1 mounts on top of a Canon TX3000/4000 or iPF 4000(S) wide format printer- Together with the integrated 64bit Linux-PC and the 21" touchscreen, the result is a powerful, economical MFP solution, featuring the best in industry scanning capabilities.*

*In its normal position, the scanner can easily be operated, and the ink tanks are fully accessible. The scanner gently slides to the back position and latches there for full access to the front cover. The scanner is operable in both positions, depending on the user's preference.*

*Using the latest camera technology and the built-in closed loop color calibration this scanner meets or exceeds all criteria set forth in the FADGI\*\*\* guidelines and in ISO 19264-1 level B.*

**Professional Quality. Made in Germany.**

**Fastest MFP solution at the lowest possible price**  
**Delivers documents in brilliant image quality**

The WideTEK36CL-600-MF1 forms the basis of a powerful and high quality MFP system to scan, copy and archive documents at high speed together with the Canon TX-3000/4000 printers. The scanner comes with a built in PC, a 21" touchscreen, all software preinstalled and the Canon TX stand, which was developed specifically for the TX series printers.

The WideTEK36CL-600-MF1 also features a built-in closed loop color calibration function, producing the best possible copies for your selected printer and paper combination. All required software option keys are factory installed, making this the easiest to implement MFP solution in the industry.

The WideTEK36CL-600-MF1 solution is by far the fastest color CIS scanner on the market, running at 10 inches per second at 200 dpi in full color. At the full width of 36" and at 600 dpi resolution, the scanner still runs at 1.7 inches per second. The scanning speeds are tripled in black and white and greyscale modes but can be individually configured if required; for example, to scan fragile, valuable documents.

**Further highlights that make the WideTEK36CL-600-MF1 scanner the best choice for TX and iPF PRO printers**

- 100% Integration of all printer features into the ScanWizard.
- Select media type, printing quality and more as well as watch the ink levels all through one application.
- Closed loop color calibration to any media at no cost.
- All software preinstalled, assign IP address and scan/copy.
- Stand assembles in less than 30 minutes, less than 15 parts.
- No training/technician needed for setup.

**Optional software supports more printers**

The scanner's capabilities can also be enhanced by adding additional software packages that allow seamless printing to many other printers from different vendors.

- WTXX-PW-TDS: PrintWizard for Canon TDS ColorWave
- WTXX-PW-HP: PrintWizard for HP PageWide, Designjet
- WTXX-PW-EPS: PrintWizard for Epson SureColor

**Other stand options also available**

The scanner is not bound to the Canon printer forever. If you purchase the WT36-STAND, you will have a free standing ergonomical scanner which allows production level scanning and supports many different printers.

**Warranty Options:**

- WTCL-SP12M: Full coverage warranty for 12 month

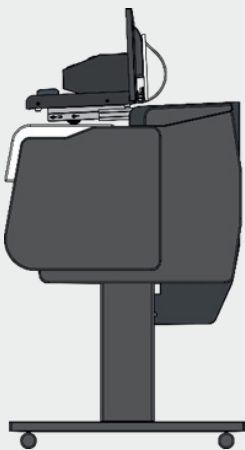

*Scanner operating in Front Position*

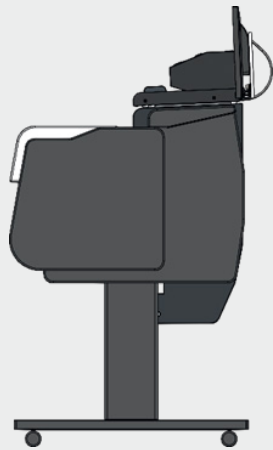

*Scanner operating in Back Position*

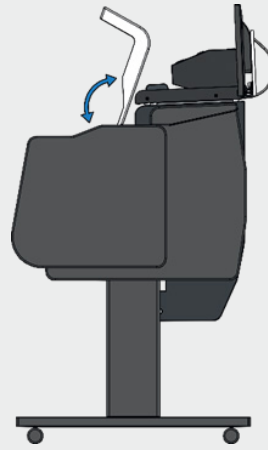

*Access to Front Cover*

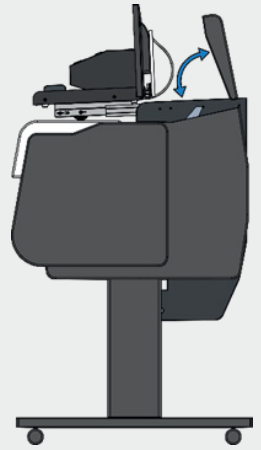

*Access to Tanks*

**WT36CL-MF1 Benefits and Advantages**

- Push back and latch for access to printer cover, pull forward for operation and access to ink tanks. No lifting, spring locking necessary.
- Both positions are fully operational.
- Only 13 parts to assemble, which can be done in less than one hour.
- 21" full HD touchscreen, compared to only 15" with other solutions.
- 64bit Linux PC integrated and all software installed. No setup of AIO, Windows10, drivers, scan software etc. necessary.
- Easy to clean, static free, all stainless-steel paper path.
- Total cost of ownership very low due to the fact, that there are no consumables.
- Production level scanning at 10" per second in full color is possible. Competing solutions are only designed for a couple of scans per day.
- Real network scanning, printer also freely accessible through its own network. Assign a valid IP and start scanning and copying.
- Closed loop color calibration included at no extra cost.
- Additional software and hardware options allow the scanner to operate with next generation Canon and other vendors' printers.
- No need to replace the scanner if printer fails or is abandoned.
- Total cost including setup is lower than almost all competition.

# What's in the Box

## The WT36CL-600-MF1 Bundle includes

- WT36CL-600-MF scanner
- Integrated 64bit Linux PC
- 21" touchscreen which mounts to the scanner
- Stand to mount on TX-3000 printer
- Extension kit for iPF 4000 PRO and TX-4000 printer
- ScanWizard and PrintWizard LFP software (pre-installed)
- Closed loop calibration software
- Calibration targets, manuals

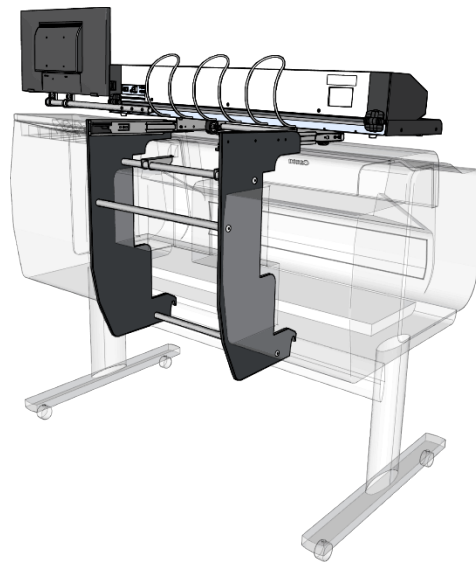

## TECHNICAL DATA

Maximum Document Size / Scan Width	965 mm (38 inch) / 915 mm (36 inch)
Scanner Resolution	1200 x 1200 dpi (optionally 9600 x 9600 dpi interpolated)
Speed in 24 bit Color, full 36" width	200 dpi - 15 m/min (10 inch/s), 300 dpi - 10.2 m/min (6.7 inch/s)
	600 dpi - 2.5 m/min (1.7 inch/s), 1200 dpi - 1.2 m/min (0.8 inch/s)
Speed in 8 bit Grayscale, full 36" width	200 dpi - 22.9 m/min (15 inch/s), 300 dpi - 22.9 m/min (15 inch/s)
	600 dpi - 8 m/min (5 inch/s), 1200 dpi - 3.8 m/min (2.5 inch/s)
Color Depth / Scan Output	48 bit color, 16 bit grayscale / 24 bit color, 8 bit grayscale, bitonal, enhanced halftone
File Formats	Multipage PDF (PDF/A) & TIFF, JPEG, JPEG 2000, PNM, PNG, BMP, TIFF (Raw, G3, G4, LZW, JPEG)
	AutoCAD DWF, JBIG, DjVu, DICOM, PCX, Postscript, EPS, raw data
ICC Profiles	Embedded for sRGB, Adobe RGB and native. Individual profiling via web based Scan2ICC subscription
Quality	Exceeds FADGI *** guidelines, ISO 19264-1
Camera	3 x Canon CIS modules, 22,389 pixels, encapsulated and dust-proof, instant-on RGB LED lights
Computer	64 bit Linux, Intel quad core processor, 128GB SSD, 8 Gigabyte RAM, for very long scans
Touchscreen	21 inch touchscreen with arm mounted to the scanner
USB Port	1 USB Port for data storage on front of scanner
Interface	1 GBit fast Ethernet with TCP/IP based Scan2Net® interface
Media Path	All stainless steel, face up, front loading, and front/rear exit media path
Integrated stand	Integrated stand mounted to Canon printers TX3000/4000 and IPF PRO 4000(S)
Software preinstalled	ScanWizard, PrintWizard Canon LFP
Software Options	PrintWizards for Canon TDS, HP PageWide and DesignJet, Epson SureColor
Dimension	170 x 1088 x 358 mm (6.7 x 42.8 x 14.1 inch) (H x W x D)
Weight	21 kg / 47 lbs.+ 8 kg / 20 lbs. for the stand
Electrical Connection	100 – 240 V AC, 47 – 63 Hz (external power supply, complies with ECO standard CEC level VI)
Power Consumption	< 0.5 W (Sleep) / approx. 5 W (Standby) / < 25 W (Ready to scan) / < 45 W (Scanning)
Operating Conditions	5 to 40 °C, 40 to 105 °F, relative humidity 20 to 80 % (non-condensing)
Noise	< 35 dB(A) (Scanning) / < 25 dB(A) (Standby)
Approvals	IEC 62386-1, UL62368-1, CSA C22,2#62368-1; CB, CE, FCC, BIS, CCC, RoHS

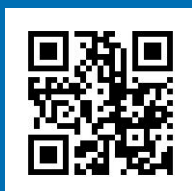

Visit our homepage!

IMAGE ACCESS GMBH

Hatzfelder Str. 161-163  
42281 Wuppertal, Germany  
Phone: +49 202 27058-0

[www.imageaccess.de](http://www.imageaccess.de)

IMAGE ACCESS LP

2511 Technology Drive, Suite 109  
Elgin, IL 60124, USA  
Phone: +1 (224) 293-2585

[www.imageaccess.us](http://www.imageaccess.us)

Technical changes, errors and omissions excepted.  
All information subject to change. © Image Access GmbH 2019